

# Optional goods for clean mat

## Aluminum slope

Prevent to get stuck to the end of the mat and reduce the risk of damage.

POINT

- 1 Made of aluminum that is not heavy and durable.
- 2 Reduce the step of mats when the hand trucks pass.
- 3 Prevent the damage of mats.
- 4 It is sold from a piece. It is possible to install easily with double sided tape.



### Aluminum slope 3mm type

It can be used with LIFT-MAT/STEP-MAT 3mm thick.

| Part Number       | Size (mm) | Thickness (mm) | Color  |
|-------------------|-----------|----------------|--------|
| <b>MAT3-SLA09</b> | 900×60    | 3.0            | Silver |
| <b>MAT3-SLA10</b> | 1000×60   |                |        |
| <b>MAT3-SLA12</b> | 1200×60   |                |        |

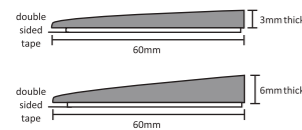

### Aluminum slope 6mm type

It can be used with STEP-MAT 6mm thick.

| Part Number       | Size (mm) | Thickness (mm) | Color  |
|-------------------|-----------|----------------|--------|
| <b>MAT6-SLA09</b> | 900×60    | 6.0            | Silver |
| <b>MAT6-SLA12</b> | 1200×60   |                |        |



### Aluminum slope corner 3mm type

It is a slope that covers damage to the mat due to vehicles entering from an oblique direction.

| Part Number      | Size (mm)   | Thickness (mm) | Color  |
|------------------|-------------|----------------|--------|
| <b>MAT3-SLAC</b> | ▲type 60×60 | 3.0            | Silver |

CHECK

For sizes not listed above, we cut and provide standard products. Please feel free to contact us. (\*Cutting fee will be charged separately.)

## Under-mat

This is the under-mat to reduce the step. Put the STEP-MAT in the frame. It is possible to install with double sided tape.

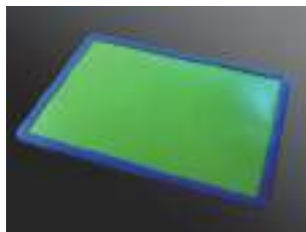

| Part Number      | Size (mm)                 | Thickness (mm) | Color        | Compatible with |
|------------------|---------------------------|----------------|--------------|-----------------|
| <b>UMAT-4590</b> | 1000×550 (all dimensions) | 3.0            | Base : Green | MAT3-4590V      |
| <b>UMAT-0906</b> | 990×690 (all dimensions)  |                | Slope : Blue | MAT3-0906V      |

\*STEP-MAT is sold separately.  
\*There is about 3mm concave at center.

## Disinfectant cleaner



This is special detergent for mats and rollers. It has an effect of sterilization.

POINT

- 1 This is special detergent for LIFT-MAT / STEP-MAT / Adhesive roller to clean easily.
- 2 It has an effect of sterilization.
- 3 It is possible to use as soon as cleaning because it is dried easily.
- 4 The mats and rollers get to be hard to damage.



### Disinfectant cleaner Spray type

| Part Number     | Volume | Details           |
|-----------------|--------|-------------------|
| <b>MAT-CL05</b> | 500mℓ  | With spray bottle |



### Disinfectant cleaner Refilled type

Attach the cock of accessory to refill your spray bottle.

| Part Number     | Volume | Details                     |
|-----------------|--------|-----------------------------|
| <b>MAT-CL10</b> | 10ℓ    | 1 box *Without spray bottle |

## Sponge mop

It is possible to drain off water by lever at hand, and this mop is hard to go out dust.



| Part Number     | Size (cm)   |
|-----------------|---|
| <b>MAT-MOP3</b> | Length of mop : about 99-132cm Width of sponge : about 27cm |

\*It is possible to control a length of handle. \*Please use after a sponge gets to be soft well with wetting.  
\*There is a case that a part of sponge may be damage, so please return the lever completely before use.

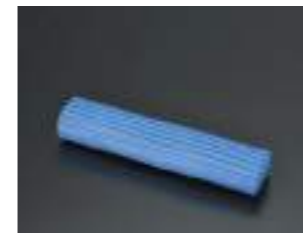

### Spare of Sponge mop

| Part Number       | Size (cm)                    | Quantity |
|-------------------|------------------------------|----------|
| <b>MAT-MOP3-S</b> | Width of sponge : about 27cm | 1        |

Remove the dust and grime of clothes, gloves, and floor.

## Adhesive roller series

POINT

- 1 It can be used repeatedly by washing with water, and it is not peeling type.
- 2 Remove a dust by self-adhesive of urethane.
- 3 Antibacterial, antifungal, and antiviral agents were mixed.
- 4 Silicone is not included in roller part. (\*Excluding handle)

Image for use

Check the video ▶▶



In front and behind of clean room.

Before entering workrooms.

To clean smooth floor.

To clean carpets.

Structure (There are protective films on surface of the product.)

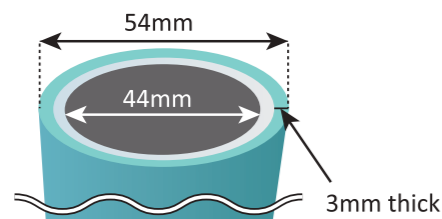

It is used to hold in hands and roll on clothes, then remove the dirt of hands and clothes. The soft gel with thickness fits uneven surface of hand and clothes, and remove a dust firmly.

|       |       |                  |     |
|-------|-------|------------------|-----|
| Outer | Φ54mm | Thickness of gel | 3mm |
| Inner | Φ44mm |                  |     |

How to clean Check the video ▶▶



The dirt of roller is rubbed softly with the palm with running water, and adhesive force will return to normal after dried. So it is possible to use repeatedly. Then it does not scatter dust because it does not peel unlike a conventional roller. It is possible to use longer and more clean with using our special detergent.

Test of removal rate Check the details ▶▶



|                                     |                        |
|-------------------------------------|------------------------|
| <b>! ATP (+AMP) Wipe inspection</b> |                        |
| EXSEAL's roller                     | Peeling type of roller |
| <b>90% or more</b>                  | about 60%              |

\*Lumitester is made by Kikkoman.

\*This result is confirmation test in-house. There is also the case that the same result can not be obtained.

Peeling type of roller does not remove about 40% of dust and grime, so dusts may move with the hands or clothes. While EXSEAL's roller can remove 90% or more.

Caution

Required size and indication of use

It is possible to use for 1-2 years. (Depending on the operating environment and frequency of use.)

### Hand-roller (For gloves)



It is for gloves, and used to hold in or roll on hands. There are two sizes.



| Part Number | Roller Size (mm) | Color      |
|-------------|------------------|------------|
| HR15-5010V  | Φ54×100          | Blue green |
| HR15-5016V  | Φ54×160          |            |

### Body-roller (For body)



It is for body, which with a handle to make it easier to have. It can easily reach your back.



| Part Number  | Roller Size (mm)                      | Color      |
|--------------|---------------------------------------|------------|
| BR15-5016V   | Φ54×160 (all dimensions : about 35cm) | Blue green |
| BR15-5016V-S | Φ54×160 Spare of roller               |            |

\*Please do not store while remaining in contact with wall or floor.

\*Two caps to attach handle are included spare of roller.

### Roller cap



For Body roller and Body roller semiconductor type (P.28). Bearings are used.

| Part Number | Size (mm) | Quantity |
|-------------|-----------|----------|
| R-CAP       | Inner Φ44 | 2        |

### Carpet-roller (For carpet)



It is long handle type with a removable grip to clean carpet conveniently.



| Part Number  | Roller Size (mm)                       | Color      |
|--------------|--|------------|
| CR15-5016V   | Φ54×160 (all dimensions : about 106cm) | Blue green |
| CR15-5016V-S | Φ54×160 Spare of roller                |            |

\*Please do not store while remaining in contact with wall or floor.

\*It cannot be used to wooden floor because the adhesive power is strong.

\*Two caps to attach handle are included spare of roller.

### Floor-roller (For wooden floor)



It is long handle type with a removable grip to clean smooth floor conveniently.



| Part Number  | Roller Size (mm)                       | Color |
|--------------|--|-------|
| FR30-5016V   | Φ54×160 (all dimensions : about 106cm) | Green |
| FR30-5016V-S | Φ54×160 Spare of roller                |       |

\*Please do not store while remaining in contact with wall or floor.

\*Two caps to attach handle are included spare of roller.

CHECK

Custom-width are also available, please contact us. (Inner Φ44mm / Outer Φ54mm)

\*Maximum width : 500mm

Adhesive sheet for wall in air shower.

# Dust catcher

POINT

- 1 Catch the dust and hair that are floating inside the air shower.
- 2 It is not used double sided tape. Glue does not believe remnants, because of the self-adhesive.
- 3 Antibacterial, antifungal, and antiviral agents were mixed.
- 4 It is economical because it can be used for a few years if you place it once.

Image for use

Check the video ▶▶



On the wall in air shower.

Catch the dust and hair.

Emboss processing for peel off easily.

Size is adjustable with scissors.

Structure (There are protective films on both sides of the product.)

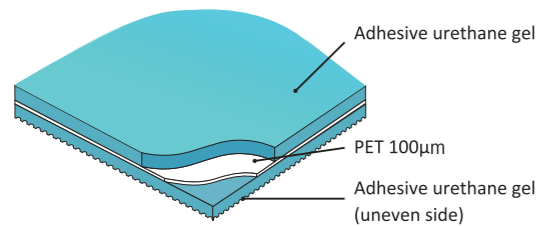

Adhesive urethane gel catch and remove dust and grime. The surface on the wall side is embossed, which allows air to escape easily and is easy to peel off. And it is possible to install to the wall of air shower without double sided tape because the material has a self-adhesive.

How to clean



Spray water or our special detergent (DC cleaner) from 15cm apart the wall when you clean as it is on the wall. After that, wipe it off immediately with a cloth that has been dampened with water and wrung out.

\*Fully washable. Please install again after dried well.

How to use

Check the video ▶▶

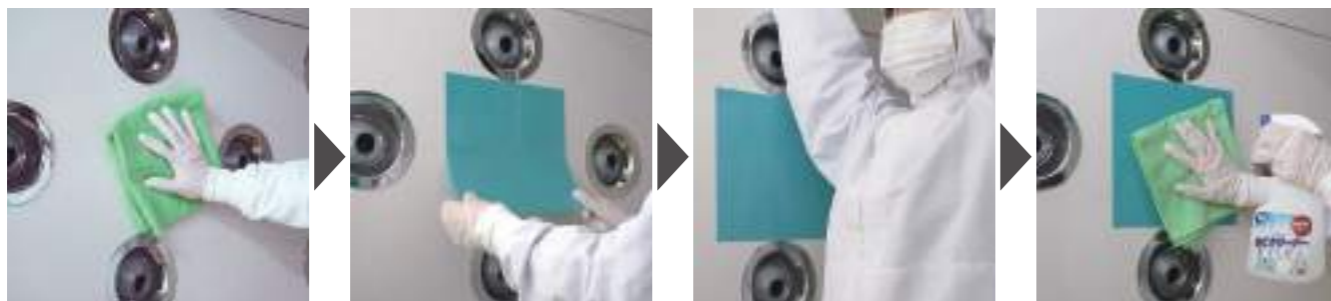

Clean the wall where you will install it.

Paste with the embossed surface facing the wall.

Adsorbs dust floating in the air shower with the power of gel.

If it gets dirty, it is possible to use repeatedly by wiping it with water and washing it.

Caution

Notes

- Allow to dry completely before pasting. If you stick it on the wall with moisture remaining, it may cause mold.
- If you fold the sheet when peeling it, it will leave a mark.
- It may be changed color of surface if oil attach to the sheet.
- Avoid installing on floors containing a lot of soft PVC or plasticizer.

Required size and indication of use

- It is possible to use for 2-3 years. (Depending on the operating environment and frequency of use.)
- Please use 6-8 sheets (250x250mm or 500x125mm) for 1m<sup>2</sup>.

Indication of cleaning

- Clean the surface once every 1-2 weeks.
- The number of cleaning is different by degree of dirt. The above is an approximate guideline.
- We recommend that you change the number of sheets and cleaning by the operating environment.
- It is possible to use longer and more clean with using our DC cleaner.



## Dust catcher

This is an adhesive sheet for wall to remove the floated dusts in air shower.



| Part Number | Size (mm) | Thickness (mm) | Color      | Quantity |
|-------------|-----------|----------------|------------|----------|
| DC10-2525V  | 250×250   | 1.0            | Blue green | 8        |
| DC10-0512V  | 500×125   |                |            |          |
| DC10-1005V  | 1000×500  |                |            | 1        |

\*DC10-1005 is free size. It is possible to cut to the size of your choice with scissors or roller cutters.

CHECK

Custom-sized are also available, please contact us.

Recommended for beginners

## Dust catcher 3 pieces set

The great deal set with DC cleaner (500ml) and DC cloth (2pcs).

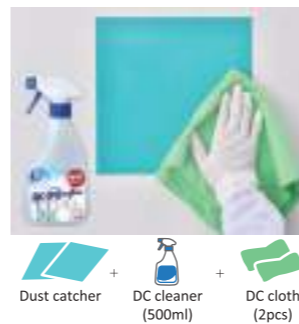

| Part Number   | Size (mm) | Thickness (mm) | Details                                       |
|---------------|-----------|----------------|---|
| DC10-2525VSET | 250×250   | 1.0            | Dust catcher (8 sheets), DC cleaner, DC cloth |
| DC10-0512VSET | 500×125   |                |   |

## DC cleaner

This is special detergent for Dust catcher. It has an effect to keep clean.



| Part Number | Volume | Details                     |
|-------------|--------|-----------------------------|
| DC-CL05     | 500mℓ  | With spray bottle           |
| DC-CL10     | 10ℓ    | 1 box *Without spray bottle |

## DC cloth

This cloth made by microfiber to get off dust and dirt adhering to Dust catcher.



| Part Number | Size (mm) | Color | Quantity |
|-------------|-----------|-------|----------|
| DC-C2       | 400×400   | Green | 2        |

\*Please wring firmly after wetting.

# Tip remover

**POINT**

- 1 The adhesive gel for fingertips that can be used repeatedly by washing with water.
- 2 The gel fits fingers firmly because of hollow inside.
- 3 Silicone and plasticizer are not included.
- 4 It is possible to install at desk by self-adhesive of gel.

Image for use



To remove fine dust of fingers. Soft gel fits fingers. It is easy to hold because of hollow inside. Can be installed on the wall or top side.

How to clean



Dirt can be removed by softly rubbing it with the palm of your hand while running water, and the adhesive force will be restored when it dries. By using a disinfectant cleaner, you can use it cleanly for a longer time.

Structure

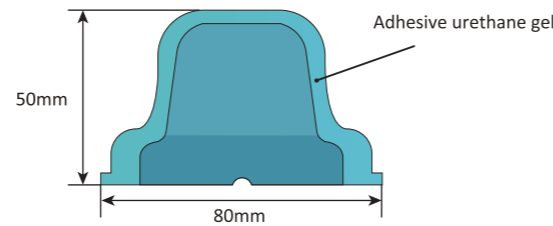

Due to its hollow structure, the soft gel fits well on your fingers and removes dirt. The shape is easy to hold in your hand.



## Tip remover

This adhesive gel for fingertips to remove fine dust of gloves and sebum.



| Part Number | Hardness  | Size (mm)                  | Color      |
|-------------|-----------|----------------------------|------------|
| TR-30       | Asker C30 | Bottom : Φ80 x Height : 50 | Blue green |



### Tip remover semiconductive type

| Part Number | Hardness  | Size (mm)                  | Color | Surface resistance (Ω) |
|-------------|-----------|----------------------------|-------|------------------------|
| TRE-30      | Asker C30 | Bottom : Φ80 x Height : 50 | Black | 10 <sup>9</sup>        |

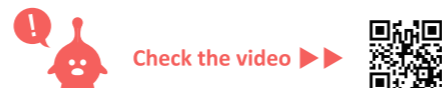

# Haimen mat

**POINT**

- 1 The soft adhesive sheet and mat fit in the deep unevenness of the back.
- 2 It can be washed with water and used repeatedly, making it easy to clean.
- 3 The mat can be attached and removed according to the situation, and the position can be adjusted freely.
- 4 Antibacterial, antifungal, and antiviral agents were mixed.

Image for use



For finishing after cleaning with roller. It is easy to paste and peel off.

Comparison of contact area

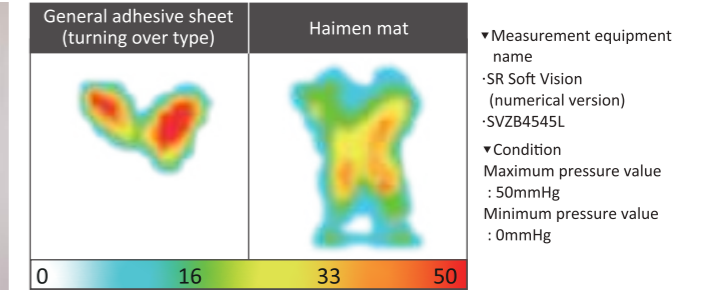

The contact area is about 2.6 times\* larger than a general adhesive sheet, and it firmly adsorbs dust. \*Haimen mat results in 259 when the area of a general adhesive sheet is 100.

How to clean



Spray water or our special detergent (DC cleaner) from 15cm apart the wall when you clean as it is on the wall. Then wipe with squeezed cloth immediately.

\*It is possible to wash without taking it part. Please install again after dried well.

Structure

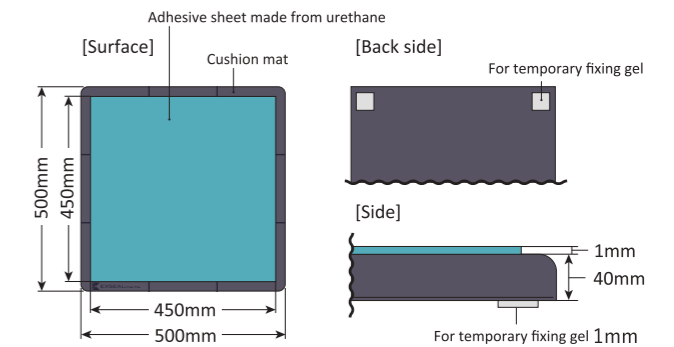

## Haimen mat

An adhesive mat that removes hair and dust from the back.



| Part Number | Size (mm) | Thickness (mm) | Detail  |
|-------------|-----------|----------------|---|
| HM-0505     | 500×500   | approx.42      | Adhesive sheet 2pcs, Cushion mat (With adhesive gel for temporary fixing) 1pc |
| HM-0505-S   | 450×450   | 1.0            | For replacement adhesive sheet 2pcs   |

\*Depending on the material and condition of the wall, it may not be possible to install it with the included gel. In that case, please note that we cannot take any responsibility. \*Please check the adhesive strength of the gel in an inconspicuous place before sticking it onto the wall. \*Avoid using fixing gel to install on soft PVC or materials containing a lot of plasticizer. \*If it is difficult to paste, please use another method such as using double-sided tape.

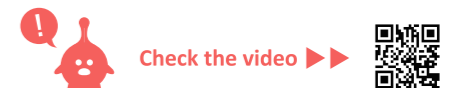

The case for conveyance of precision devices.

# GEL-BASE<sup>®</sup> series

POINT

- 1 Soft gel prevents some damages from vibration during convey the precision parts.
- 2 Since no adhesive is used, an adhesive does not transfer to parts.
- 3 Silicone is not used as material.
- 4 Cloudy and Mesh type have an uneven surface, so it is possible to pick up without a vacuum equipment.

Image for use

Check the video ▶▶

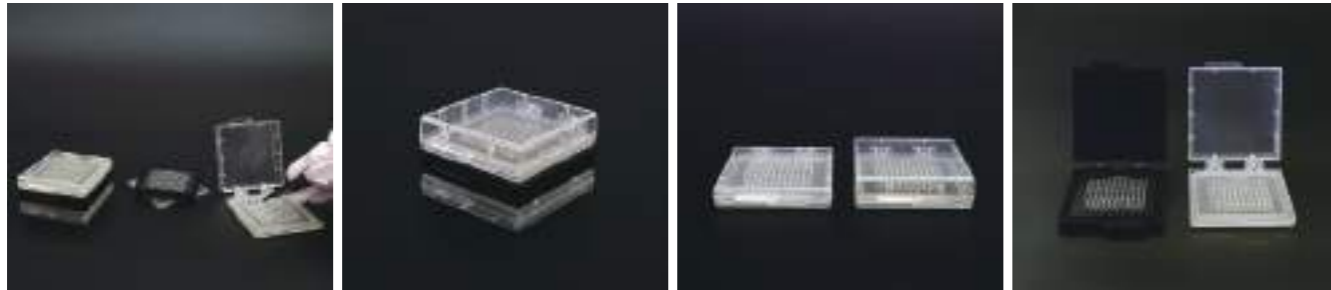

Adhesive gel has an uneven surface, so it is possible to pick up easily without a vacuum equipment. (Cloudy / Mesh)  
 Case and tray are stackable.  
 The height of case for 2-inch is two types. The colors of cases are black and clear. (Left) Type L / (Right) Type H

## Characteristics / Product dimensions

\*We also hear to custom printing. (Special order) \*Measured value is a reference, not guaranteed value.

### GEL-BASE<sup>®</sup> 2-inch

|      | Size (mm)         | Color | Surface resistance (Ω) | Silicone        |                 |
|------|-------------------|-------|------------------------|-----------------|-----------------|
| Case | Type L : 54×54×11 | Black | 10 <sup>11</sup>       | Non Silicone    |                 |
|      | Type H : 54×54×16 | Clear | 10 <sup>13</sup>       |                 |                 |
| Tray | 50.8×50.8×4       | Black | 10 <sup>11</sup>       |                 |                 |
|      |                   | Clear | 10 <sup>13</sup>       |                 |                 |
| Gel  | 42×42             | Amber | FS9                    |                 | 10 <sup>9</sup> |
|      |                   |       | F7                     |                 | 10 <sup>9</sup> |
|      |                   |       | F5                     |                 | 10 <sup>8</sup> |
|      |                   |       | F3                     |                 | 10 <sup>7</sup> |
|      |                   |       | C7                     |                 | 10 <sup>9</sup> |
|      |                   |       | C5                     |                 | 10 <sup>8</sup> |
|      |                   |       | C3                     | 10 <sup>8</sup> |                 |
|      |                   |       | E7                     | 10 <sup>9</sup> |                 |
| E5   | 10 <sup>8</sup>   |       |                        |                 |                 |

### Case / Tray

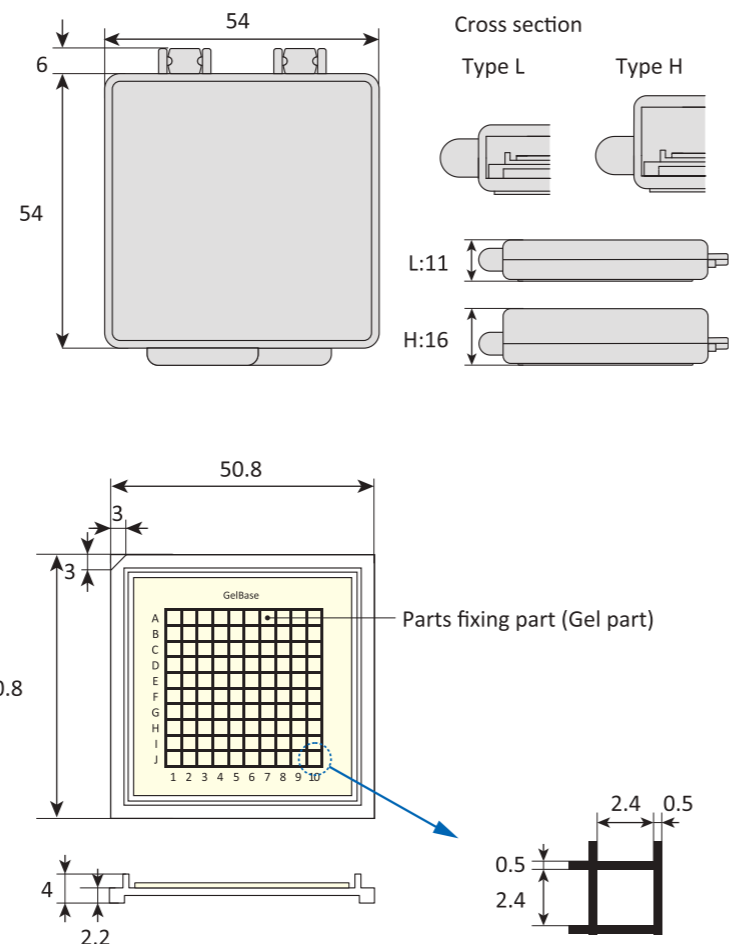

## Adhesive properties of GEL-BASE

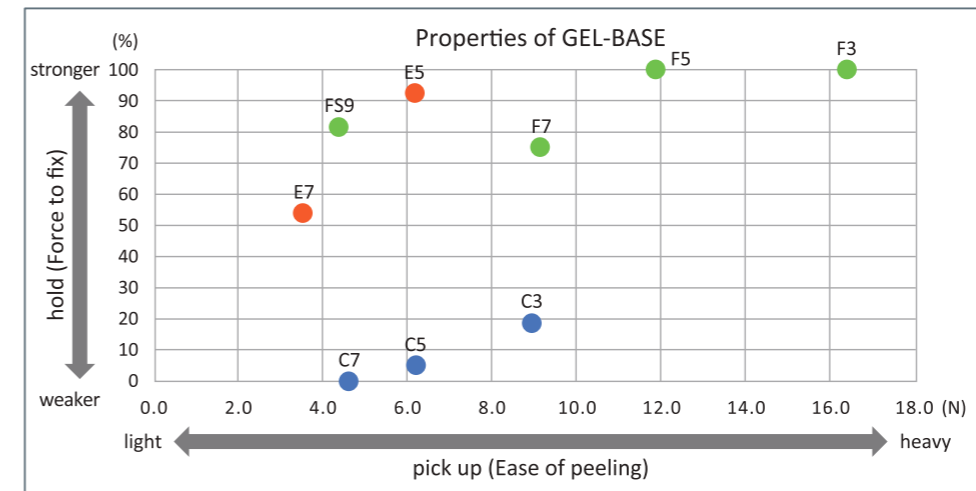

\*Varies depending on surface condition, material, weight and size.  
 \*A glass plate is used for the pick-up test, and a ceramic plate is used for the hold test.  
 \*"Pick up" means how easy it is to peel off the conveyed product.  
 \*"hold" means the force to fix the conveyed product.  
 \*Measured values are reference values, not guaranteed values.

## GEL-BASE<sup>®</sup> 2-inch

A set of case and tray. It is possible to remove a tray. Please choice the height and color of case.



### GEL-BASE<sup>®</sup> 2-inch Flat type

| Part Number                    | Shape of gel | Adhesive force (N/25mm) | Clearance |
|--------------------------------|--------------|-------------------------|-----------|
| Black: CB-FS9L, Clear: CT-FS9L | Flat FS9     | approx. 0.007           | 2.0mm     |
| Black: CB-F7L, Clear: CT-F7L   | Flat F7      | approx. 0.24            |           |
| Black: CB-F5L, Clear: CT-F5L   | Flat F5      | approx. 1.23            |           |
| Black: CB-F3L, Clear: CT-F3L   | Flat F3      | approx. 1.51            |           |
| Black: CB-FS9H, Clear: CT-FS9H | Flat FS9     | approx. 0.007           | 7.0mm     |
| Black: CB-F7H, Clear: CT-F7H   | Flat F7      | approx. 0.24            |           |
| Black: CB-F5H, Clear: CT-F5H   | Flat F5      | approx. 1.23            |           |
| Black: CB-F3H, Clear: CT-F3H   | Flat F3      | approx. 1.51            |           |

\*Adhesive force (N/25mm) is a reference value.



### GEL-BASE<sup>®</sup> 2-inch Cloudy type

| Part Number                  | Shape of gel | Adhesive force (N/25mm) | Clearance |
|------------------------------|--------------|-------------------------|-----------|
| Black: CB-C7L, Clear: CT-C7L | Cloudy C7    | approx. 0.04            | 2.0mm     |
| Black: CB-C5L, Clear: CT-C5L | Cloudy C5    | approx. 0.14            |           |
| Black: CB-C3L, Clear: CT-C3L | Cloudy C3    | approx. 0.74            |           |
| Black: CB-C7H, Clear: CT-C7H | Cloudy C7    | approx. 0.04            | 7.0mm     |
| Black: CB-C5H, Clear: CT-C5H | Cloudy C5    | approx. 0.14            |           |
| Black: CB-C3H, Clear: CT-C3H | Cloudy C3    | approx. 0.74            |           |

\*Adhesive force (N/25mm) is a reference value.



### GEL-BASE<sup>®</sup> 2-inch Mesh type

| Part Number                  | Shape of gel | Adhesive force (N/25mm) | Clearance |
|------------------------------|--------------|-------------------------|-----------|
| Black: CB-E7L, Clear: CT-E7L | Mesh E7      | approx. 0.09            | 2.0mm     |
| Black: CB-E5L, Clear: CT-E5L | Mesh E5      | approx. 0.48            |           |
| Black: CB-E7H, Clear: CT-E7H | Mesh E7      | approx. 0.09            | 7.0mm     |
| Black: CB-E5H, Clear: CT-E5H | Mesh E5      | approx. 0.48            |           |

\*Adhesive force (N/25mm) is a reference value.

CHECK

We also accept consultations regarding printing specifications for adhesive strength and part fixing parts.

The case for conveyance of precision devices.

# GEL-BASE<sup>®</sup> series



## GEL-BASE<sup>®</sup> No tray type

- POINT**
- 1 Clearance is larger than normal GEL-BASE 2-inch.
  - 2 Since the gel sheet is attached directly to the case, the number of parts is reduced, and making it easier to manage.
  - 3 Silicone is not used as material.

### Image for use



The tray of GEL-BASE 2-inch type is removed, and the gel sheet is attached directly to the case. Case and tray are stackable. Many parts can be placed regardless of squares. It is also possible to print the squares on the case. (\*Special order available)

### Comparison of clearance



Clearance is getting bigger because there is no tray. Higher parts can be stored and transported.

**CHECK** We also accept special orders for printing squares directly on the case. Please feel free to contact us.



### GEL-BASE<sup>®</sup> 2-inch Flat type No tray

| Part Number | Color of case | Shape of gel | Adhesive force (N/25mm) | Clearance |
|-------------|---------------|--------------|-------------------------|-----------|
| TLCB-F7H    | Black         | Flat F7      | approx. 0.24            | 10.0mm    |
| TLCB-F5H    |               | Flat F5      | approx. 1.23            |           |
| TLCT-F7H    | Clear         | Flat F7      | approx. 0.24            |           |
| TLCT-F5H    |               | Flat F5      | approx. 1.23            |           |

\*Adhesive force (N/25mm) is a reference value.



## GEL-BASE<sup>®</sup> V type

- POINT**
- 1 This is a precision parts transport case with non-silicone that picks up parts using a vacuum device.
  - 2 It can firmly fix parts during transport, and also easily pick up parts during vacuuming.
  - 3 The adhesive strength does not change over time, keeping the lightness of the pick up.

### Image for use



It can be easily picked up by vacuuming with a vacuum device. For storing and transporting parts such as glass, wafers, and ceramics.

### Pickup value by device paste time

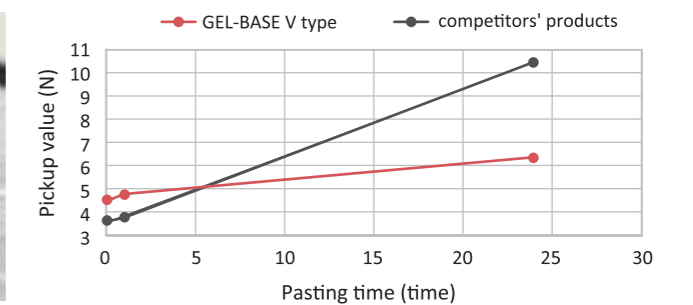

\*Using a glass plate for the device.  
\*Measured values are reference values, not guaranteed values.

### Structure

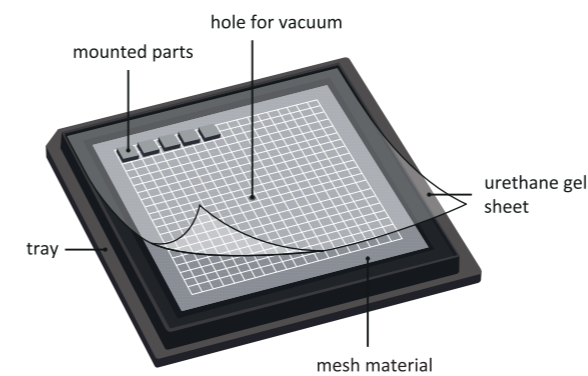

The tray of GEL-BASE V type has a vacuum hole for a vacuum device on the back. By using a vacuum device during work such as pickup, the urethane gel sheet on the surface becomes a mesh.

### Mechanism of vacuuming



As the urethane gel sheet get into the mesh material deeply when vacuumed, it can be seen that the contact area with the parts is smaller.

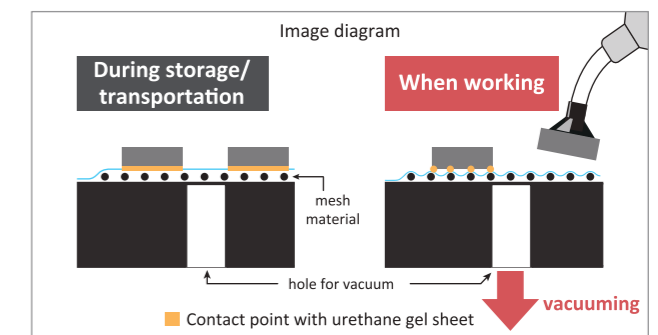

### GEL-BASE<sup>®</sup> 2-inch V type

| Part Number | Color of case | Shape of gel | Adhesive force (N/25mm) | Clearance |
|-------------|---------------|--------------|-------------------------|-----------|
| CB-VS9L200  | Black         | Flat FS9     | approx. 0.007           | 2.0mm     |

\*Adhesive force (N/25mm) is a reference value.

